

## Professional in HVAC/R Tools



**VALUE Mechanical & Electrical Products CO., LTD**

Add: Jiulong Avenue, Western Industrial District, Wenling, Zhejiang, China

Tel: +86-576-86191959

Fax: +86-576-86191957

Email: [value@worldvalue.cn](mailto:value@worldvalue.cn)

[www.worldvalue.cn](http://www.worldvalue.cn)

2017 - 2018  
[www.worldvalue.cn](http://www.worldvalue.cn)



## The global leading in refrigeration tools and vacuum solutions

- To provide the best user experience products and services through innovative technology
- To help users finish works through easier, more efficient, higher quality, and to succeed
- High quality is the basic guarantee of creating value for users





## HONOR & CAPABILITY

VALUE is honored as National High Tech-Science Corporation, Member of National Vacuum Technique Standardization Technical Committee, China Porch Program Corporation, National Sci-Innovative Enterprise, UN Environment Programme Equipment-Bidder Enterprise, China Aviation Industry Supporting Corporation.....

With the annual production capacity of 500,000 pieces VALUE achieved the turnover of 42 million USD in 2016, with 30 million USD from global markets.

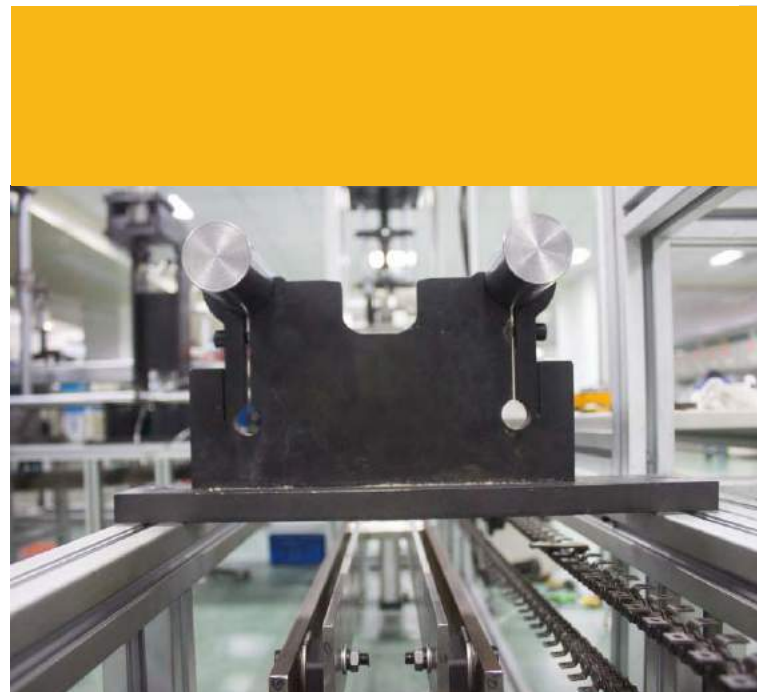

## INNOVATION

VALUE commits continuous investments to R&D, to develop better products. We invest 15 million in research every year, and have got over 140 patents in China.

VALUE possesses a large number of talents, with 35% of whom are high-educated experts. With over 40 senior experts in motor, electric, vacuum technology and industrial designing, we are capable of offering personalized design and service for you in the shortest time.

## QUALITY

Our products are qualified with world's most advanced quality level. We have European CE, American UL, Canada CSA safety certificates and German TUV ISO9001 certificate. And we also own product failure analysis lab, homo-thermal and homo-humid workshop, product model experiment center.

VALUE is fully equipped with modernized processing and testing instruments, such as Japan DMG Mori Seiki horizontal machining center, Japan OKUMA-BYJC vertical machining center, German WENZEL three coordinates measuring equipment, etc. We carry out ERP data management and precise manufacture mode.

## GLOBAL DISTRIBUTION

VALUE has sound sales network which covers more than 90 countries and regions, such as US, Japan, France, Italy, Spain, German, North Europe, Korea, Taiwan, Brazil, etc.

VALUE has also built our own brand distribution network in over 80 countries. VALUE provides products and service for 10 Fortune 500 enterprises as well.

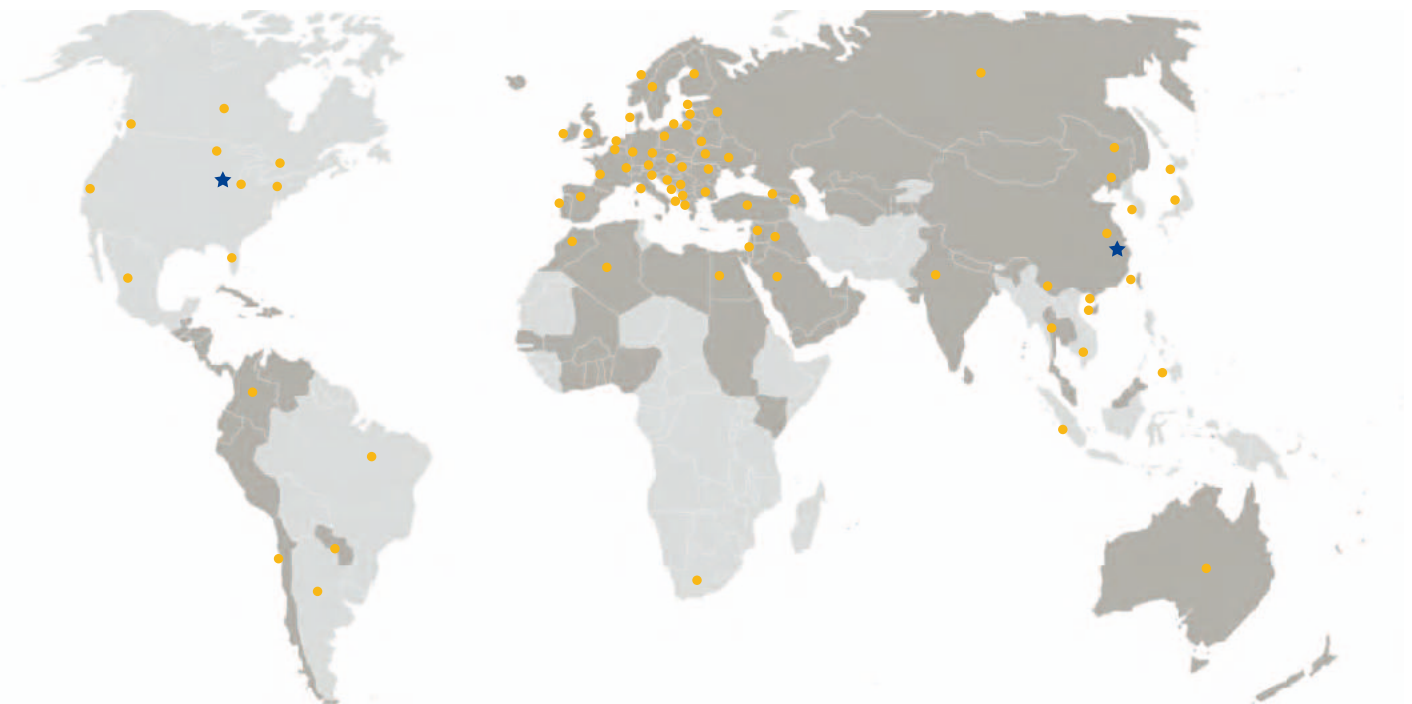

## Mission of VALUE

### —VALUE creates value

We provide customers with innovative, high quality refrigeration tools and vacuum solutions, to help customers succeed, to promote the progress of science and technology.

#### 1. Create Value for Customers

VALUE is dedicated to providing innovative, high quality products, service and system solutions to help customers finish their work with higher efficiency and better quality to achieve success.

#### 2. Create Value for Staff

Staff is the most valuable treasure. VALUE helps the staff to acquire better working skills and abilities as well as personal growth.

#### 3. Create Value for Partners

VALUE is committed to establishing a long-term win-win relationship with the partners by means of building up a fair, just and open platform of cooperation.

#### 4. Create Value for Society

VALUE is intended to save the natural resources, protect the environment and expedite scientific and technological progress as well as social development.

## Vision of VALUE

1.Global leader in refrigeration tools and vacuum solutions.

- Global Market
- Leading Technology
- One of the best

2.Dream realizing Stage of employees.

## Values of VALUE

Integrity

Teamwork

Reform and innovation

The pursuit of excellence

Customer Orientation

03 VE N Series



05 New Refrigerant Series



07 R32 Refrigerant Series



13 Industrial Series



18 M Series Recovery Unit



19 L Series Recovery Unit



25 Manifold Gauge



30 Single Gauge



31 Pressure Gauge



34 Digital Manifold Gauge



36 Accessory



38 Leak Detector



39 Scale



43 Flaring Tool



48 Bending Tool



49 Tube Expander



52 Tube Cutter



53 Pipe Tools



55 Tool Kit



57 HVAC Instrument





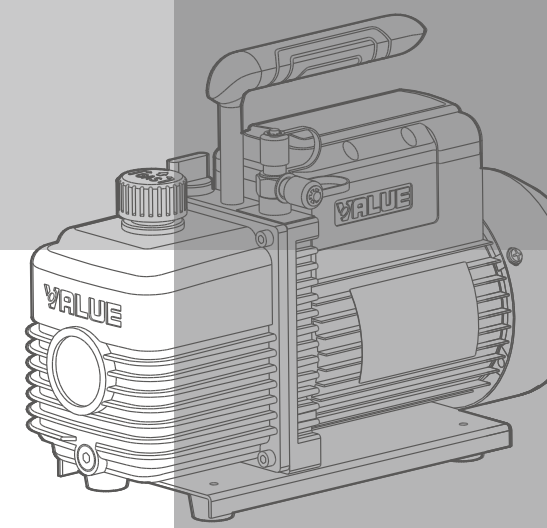

# Vacuum Pump

High Reliable



## VE N SERIES

More Reliable, Higher Ultimate Vacuum



Forced oil cycling system



Integrated body structure



Big sight glass for monitoring oil level



### Single Stage

Model	VE115N	VE125N	VE135N	VE160N	VE180N	
Flow Rate	50Hz	1.8 CFM	2.5 CFM	3.5 CFM	6.0 CFM	8.0 CFM
		51 L/min	70 L/min	100 L/min	170 L/min	226 L/min
Flow Rate	60Hz	2.0 CFM	3.0 CFM	4.0 CFM	7.0 CFM	9.0 CFM
		57 L/min	84 L/min	113 L/min	198 L/min	254 L/min
Ultimate Vacuum	Partial Pressure	2 Pa	2 Pa	2 Pa	2 Pa	2 Pa
	Total Pressure	150 micron	150 micron	150 micron	150 micron	150 micron
Power	1/4 HP	1/4 HP	1/3 HP	1/2 HP	3/4 HP	
Inlet Port	1/4" Flare	1/4" Flare	1/4"&3/8" Flare	1/4"&3/8" Flare	1/4"&3/8" Flare	
Oil Capacity	250 ml	250 ml	250 ml	415 ml	660 ml	
Dimensions	290x124x224 mm	290x124x224 mm	318x124x234 mm	338x138x244 mm	395x145x257 mm	
Weight	6.6 Kg	7.1 Kg	8.0 Kg	9.9 Kg	14.6 Kg	

### Dual Stage

Model	VE215N	VE225N	VE245N	VE260N	VE280N	VE2100N	
Flow Rate	50Hz	1.5 CFM	2.5 CFM	4.5 CFM	6.0 CFM	8.0 CFM	10.0 CFM
		42 L/min	70 L/min	128 L/min	170 L/min	226 L/min	283 L/min
Flow Rate	60Hz	1.8 CFM	3.0 CFM	5.0 CFM	7.0 CFM	9.0 CFM	12.0 CFM
		50 L/min	84 L/min	142 L/min	198 L/min	254 L/min	340 L/min
Ultimate Vacuum	Partial Pressure	2x10 <sup>-1</sup> Pa	2x10 <sup>-1</sup> Pa	2x10 <sup>-1</sup> Pa	2x10 <sup>-1</sup> Pa	2x10 <sup>-1</sup> Pa	2x10 <sup>-1</sup> Pa
	Total Pressure	15 micron	15 micron	15 micron	15micron	15 micron	15 micron
Power	1/4 HP	1/3 HP	1/2 HP	3/4 HP	1 HP	1 HP	
Inlet Port	1/4" Flare	1/4" Flare	1/4"&3/8" Flare	1/4"&3/8" Flare	1/4"&3/8" Flare	1/4"&3/8" Flare	
Oil Capacity	200 ml	200 ml	325 ml	580 ml	500 ml	590 ml	
Dimensions	308x124x224 mm	318x124x234 mm	338x138x244 mm	395x145x257 mm	395x145x257 mm	395x145x257 mm	
Weight	7.5 Kg	8.5 Kg	10.4 Kg	15.8 Kg	16.2 Kg	16.7 Kg	

## VE N SERIES

Dual Voltage (110-220V/50-60Hz)

Power plug

make this connection with different power plugs easily

Power supply conversion switch

make sure this switch is set on the right place before your operation: 110V or 220V



### Dual Stage

Model	VE215ND	VE225ND	VE245ND	
Flow Rate	50Hz	1.5 CFM	2.5 CFM	4.5 CFM
		42 L/min	70 L/min	128 L/min
Flow Rate	60Hz	1.8 CFM	3.0 CFM	5.0 CFM
		50 L/min	84 L/min	142 L/min
Ultimate Vacuum	Partial Pressure	2x10 <sup>-1</sup> Pa	2x10 <sup>-1</sup> Pa	2x10 <sup>-1</sup> Pa
	Total Pressure	15 micron	15 micron	15 micron
Power	1/4 HP	1/3 HP	1/2 HP	
Inlet Port	1/4" Flare	1/4" Flare	1/4"&3/8" Flare	
Oil Capacity	200 ml	200 ml	325 ml	
Dimensions	318x124x234 mm	318x124x234 mm	338x138x244 mm	
Weight	8.5 Kg	8.5 Kg	10.4 Kg	

Model	VE260ND	VE280ND	VE2100ND	
Flow Rate	50Hz	6.0 CFM	8.0 CFM	10.0 CFM
		170 L/min	226 L/min	283 L/min
Flow Rate	60Hz	7.0 CFM	9.0 CFM	12.0 CFM
		198 L/min	254 L/min	340 L/min
Ultimate Vacuum	Partial Pressure	2x10 <sup>-1</sup> Pa	2x10 <sup>-1</sup> Pa	2x10 <sup>-1</sup> Pa
	Total Pressure	15micron	15 micron	15 micron
Power	3/4 HP	1 HP	1 HP	
Inlet Port	1/4"&3/8" Flare	1/4"&3/8" Flare	1/4"&3/8" Flare	
Oil Capacity	580 ml	500 ml	590 ml	
Dimensions	395x145x257 mm	395x145x257 mm	395x145x257 mm	
Weight	15.8 Kg	16.2 Kg	16.7 Kg	



## NEW REFRIGERANT SERIES

Suitable for R410A, R407c, R134a, R12, R22 refrigerant



High accuracy vacuum gauge shows system pressure



Automatic anti-backflow valve design



Integrated body structure



Big sight glass for monitoring oil level



### Single Stage

Model	V-i120SV	V-i140SV	V-i160SV	V-i180SV
Flow Rate	50Hz	1.8 CFM 51 L/min	3.5 CFM 100 L/min	5.0 CFM 142 L/min
	60Hz	2.0 CFM 57 L/min	4.0 CFM 113 L/min	6.0 CFM 170 L/min
Ultimate Vacuum	Partial Pressure	2 Pa	2 Pa	2 Pa
	Total Pressure	150 micron	150 micron	150 micron
Power	1/4 HP	1/3 HP	1/2 HP	3/4 HP
Inlet Port	1/4" Flare	1/4" Flare	1/4" Flare	1/4" Flare
Oil Capacity	250 ml	250 ml	415 ml	660 ml
Dimensions	290x124x255 mm	318x124x265 mm	338x138x275 mm	395x145x318 mm
Weight	6.7 Kg	8.6 Kg	10.3 Kg	15.4 Kg

### Dual Stage

Model	V-i220SV	V-i240SV	V-i260SV	V-i280SV
Flow Rate	50Hz	1.8 CFM 51 L/min	3.5 CFM 100 L/min	5.0 CFM 142 L/min
	60Hz	2.0 CFM 57 L/min	4.0 CFM 113 L/min	6.0 CFM 170 L/min
Ultimate Vacuum	Partial Pressure	2x10 <sup>-1</sup> Pa	2x10 <sup>-1</sup> Pa	2x10 <sup>-1</sup> Pa
	Total Pressure	15 micron	15 micron	15 micron
Power	1/3 HP	1/2 HP	3/4 HP	1 HP
Inlet Port	1/4" Flare	1/4" Flare	1/4" Flare	1/4" Flare
Oil Capacity	200 ml	325 ml	580 ml	500 ml
Dimensions	318x124x265 mm	338x138x275 mm	395x145x318 mm	395x145x318 mm
Weight	9.0 Kg	11.0 Kg	16.6 Kg	17.0 Kg

## NEW REFRIGERANT SERIES

Suitable for R410A, R407c, R134a, R12, R22 refrigerant



Smaller, lighter, and more convenient  
**only 4kg**



### Specification

Model	V-i115S-M	V-i215S-M
Flow Rate	1.5 CFM	1.5 CFM
Partial Pressure	2 Pa	2x10 <sup>-1</sup> Pa
Total Pressure	150 micron	15 micron
Power	1/5 HP	1/5 HP
Inlet Port	1/4" Flare	1/4" Flare
Oil Capacity	150 ml	110 ml
Dimensions	240x88x183 mm	240x88x183 mm
Weight	3.5 Kg	4 Kg

Both AC & DC can be operated



• Chinese patent



### Specification

Model	V-i210H
Flow Rate	1.0 CFM
Partial Pressure	2x10 <sup>-1</sup> Pa
Total Pressure	15 micron
Power	1/5 HP
Inlet Port	1/4" Flare
Oil Capacity	150 ml
Dimensions	240x88x183 mm
Weight	4 Kg



## R32 REFRIGERANT SERIES



• Chinese patent 

Suit for R32, 1234yf refrigerant

Integrated body structure



Horizontal position easy for reading



Enclosed switch



### Dual Stage

Model	V-i125Y-R32	V-i240Y-R32	V-i260Y-R32	V-i280Y-R32
Flow Rate	50Hz	2.5 CFM 70 L/min	3.5 CFM 100 L/min	5.0 CFM 142 L/min
	60Hz	3.0 CFM 84 L/min	4.0 CFM 113 L/min	6.0 CFM 170 L/min
Ultimate Vacuum	Partial Pressure	2 Pa	2x10 <sup>-1</sup> Pa	2x10 <sup>-1</sup> Pa
	Total Pressure	150micron	15micron	15 micron
Power	1/4 HP	1/2 HP	3/4 HP	1 HP
Inlet Port	1/4" Flare	1/4" Flare	1/4" Flare	1/4" Flare
Oil Capacity	250 ml	325 ml	460 ml	500 ml
Dimensions	290x124x235 mm	338x138x248 mm	395x145x270 mm	395x145x270mm
Weight	7.2 Kg	11.0 Kg	16.6 Kg	17.0 Kg







• Chinese patent 

Smaller, lighter, and more convenient  
Suite for R32, 1234yf refrigerant

Model	V-i2120
Flow Rate	12 CFM
Partial Pressure	2x10 <sup>-1</sup> Pa
Total Pressure	15 micron
Power	1 HP
Inlet Port	1/4" & 3/8" Flare
Oil Capacity	500 ml
Dimensions	345x135x280 mm
Weight	11.5 Kg

## VACUUM GAUGE

VACUUM GAUGE	Gauge Diameter	Unit	Assemble	MRP NO.	Thread
	Φ50mm	mbar/inHg	Axial	310500104	NPT1/8"
	Φ50mm	mbar/inHg	Radial	310500106	NPT1/8"
	Φ63mm	mbar/Mpa/Psi	Radial	310500601	NPT1/8"
	Φ75mm	mbar	Axial	310500301	NPT1/8"
	Φ80mm	mbar/Mpa/Psi	Radial	310500405	NPT1/8"



500ml(18 Oz)



330ml(11.5 Oz)



4L(135 Oz)



1L(34 Oz)

### Vacuum Pump Oil

A wide choice of oil is available to obtain the best performance from pumps under different application conditions.

Value Vacuum Pumps can be operated with the oil listed below; using different oil can affect all specified ultimate vacuum and cold starting.

Model	VPO-46	VPO-68
Kinematic viscosity(40°C)	41.4-50.6mm <sup>2</sup> /s	61.2-74.8mm <sup>2</sup> /s
Viscosity Index	110	130
Flash Point	240°C	250°C
Pour Point	-10°C	-35°C
Type	Mineral Oil	Synthetic di-ester oil



## EXPLODED VIEW FOR VE N SERIES

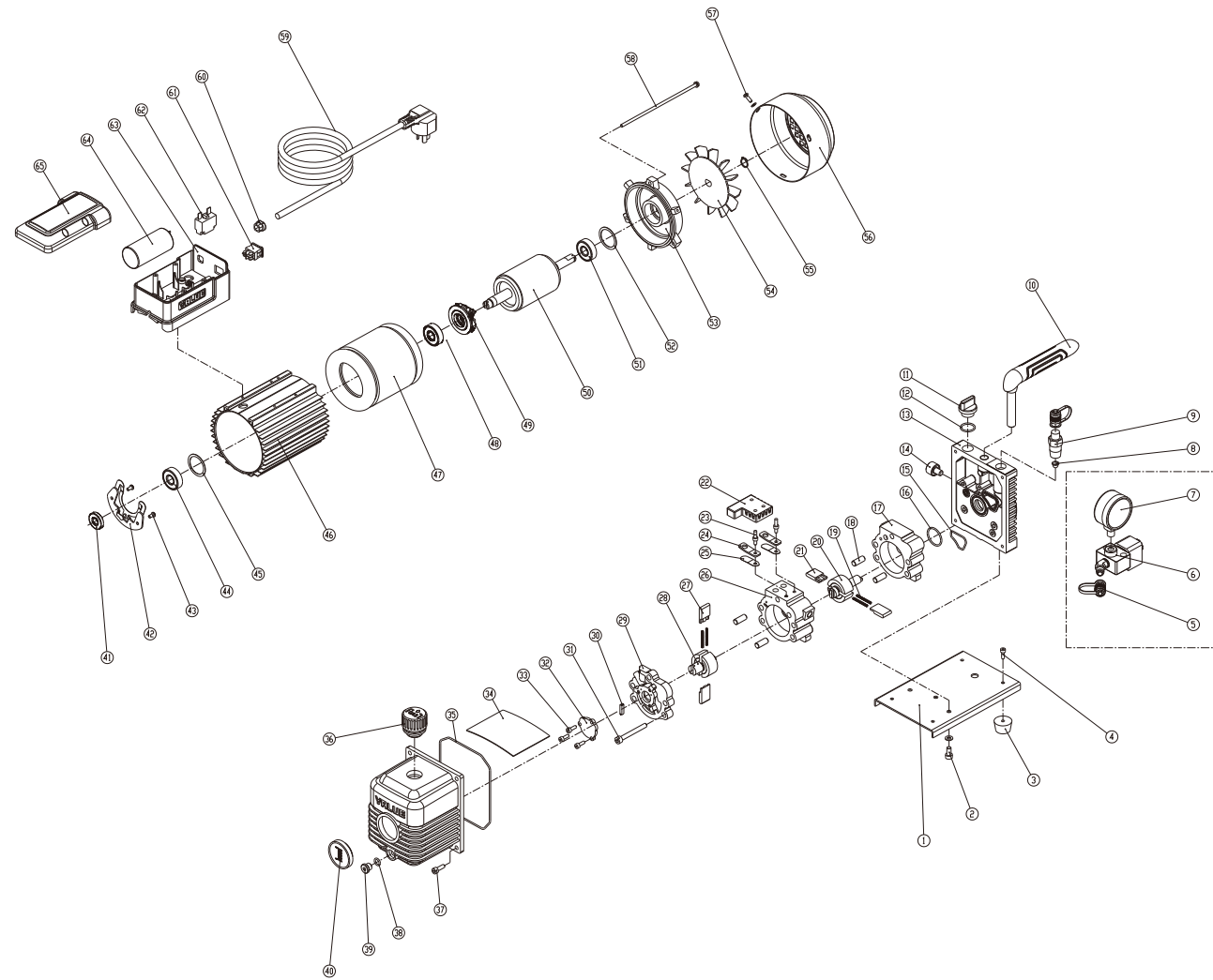

1 Base	17 Fore stator	33 Screw	49 Centrifugal switch
2 Screw	18 Round pin	34 Anti-oil plate	50 Motor rotor
3 Rubber feet	19 Spring	35 O ring	51 Bearing
4 Screw	20 Fore rotor	36 Exhausting and oil inlet fitting	52 Gasket
5 Inlet fitting cap	21 Fore rotary vane	37 Screw	53 Motor cover
6 Solenoid valve	22 Anti-oil cover	38 O ring	54 Fan
7 Vacuum gauge	23 Screw	39 Oil drain plug	55 Elastic collar
8 Filter	24 Control plate	40 Sight glass	56 Fan cover
9 Inlet fitting	25 Displacing valve	41 Seal	57 Cross screw
10 Handle	26 Back stator	42 Centrifugal switch base	58 Cross screw
11 Oil fill cap	27 Back rotary vane	43 Cross screw	59 Power supply cord
12 O ring	28 Back rotor	44 Bearing	60 Insulating bushing
13 Trestle	29 Pump back cover	45 Gasket	61 Power switch
14 Gas ballast	30 Oil pump rotary vane	46 Motor hull	62 Thermal protector
15 O ring	31 Screw	47 Motor stator	63 Junction box
16 O ring	32 Oil pump back cover	48 Bearing	64 Capacitor
			65 Junction box cover

## DIMENSION DRAWING

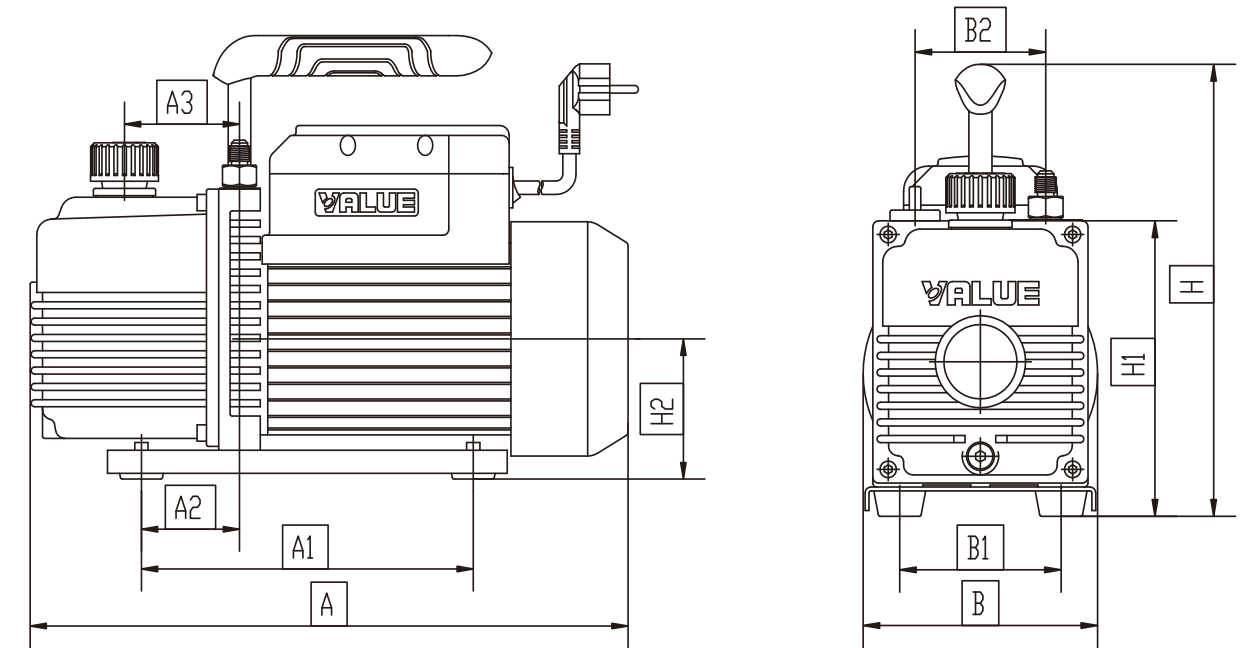

The dimension for VEN series pump(unit:mm)

Model	A	A1	A2	A3	B	B1	B2	H	H1	H2
VE115N	290	118	30	50	124	76	-	224	141	71
VE125N	290	118	30	50	124	76	-	224	141	71
VE135N	318	144	40	61	124	84	68	234	154	76
VE160N	338	144	40	61	138	84	74	244	166	78
VE180N	395	174	66	85	145	99	74	257	179	86
VE215N	308	118	30	50	124	76	-	224	141	71
VE225N	318	144	40	61	124	84	68	234	154	76
VE245N	338	144	40	61	138	84	74	244	166	78
VE260N	395	174	66	85	145	99	74	257	179	86
VE280N	395	174	66	85	145	99	74	257	179	86
VE2100N	395	174	66	85	145	99	74	257	179	86



## NEW REFRIGERANT VACUUM PUMP

### Refrigerants category

Vacuum pumps with solenoid valve should be used for pumping new refrigerants. Otherwise, there might be a risk that the pump oil returning to compressor, polluted and destroyed the refrigerants.

	New Refrigerant & Old Refrigerant Vacuum Pump		Old Refrigerant Vacuum Pump	New Refrigerant
R410A	R407C	R22	R22	R32 1234yf
	R404A	R12	R12	
	R507A	R502	R502	
	R134A	R500	R500	

### Flow rate











The flow rate of vacuum pump is usually represented by L/S, which means the working time has a direct relationship with the flow rate. It's required to select VALUE high reliable vacuum pumps which matches the equipment.

Flow Rate	1~2L/S	3~4L/S	POWER
Applicable Equipment	Household refrigerator	Central air-conditioning	Central air-conditioning
	Household air-conditioning	Large household air-conditioning	Large household air-conditioning
	Car air-conditioning	Bus air-conditioning Large refrigerated warehouse	

### Ultimate vacuum

Ultimate vacuum means the capacity of removing moisture. Pressure unit with Pa usually. The smaller figure, the higher ultimate vacuum achieves. New refrigerants central air-conditioning, Freezing and refrigeration equipment with low evaporator temperature need to use VALUE double stage vacuum pump.

	Single Stage	Dual Stage
Ultimate Vacuum	2Pa	$2 \times 10^{-3}$ Pa
Applicable Equipment	Household air-conditioning	Central air-conditioning
	Car air-conditioning	Large refrigerated warehouse
	Refrigerator	

Adapt for old refrigerant			Adapt for all refrigerant (including R22,R410A,etc...)		Adapt for all refrigerant (including R32,1234yf)
Household air-conditioning Household refrigerator Car air-conditioning	Large household air-conditioning Bus air-conditioning	Central air-conditioning Large refrigerated warehouse	Household air-conditioning	Central air-conditioning Large household air-conditioning	Central air-conditioning Large household air-conditioning
 VE115N(1L/S)	 VE160N(3L/S)	 VE245N(2L/S)	 V-i140SV(2L/S)	 V-i240SV(2L/S)  V-i280SV(4L/S)	 V-i125Y-R32 V-i240Y-R32 V-i260Y-R32 V-i280Y-R32  V-i2120
 VE135N(2L/S)	 VE180N(4L/S)	 VE280N(4L/S)	150 micron	15 micron	15 micron

## ACCESSORY

### AC Power Supply Plug

Item	Description
C01	Israel plug
C02	China plug
C03	Australia plug
C04	South Africa plug
C05	Europe plug
C06	America plug
C07	Britain plug
C08	Japan plug
C09	Italy plug
C10	Argentina plug
C11	Brazil plug



### Intake Ports Adapter



Item	Description
T2	1/4" SAE
T3	1/4" SAE & 3/8 SAE
T4	1/4" SAE & 1/2" Acme
T5	1/4" Tube
T6	1/4" Tube (Locked with M12 x1 nut)
TG3	1/4" SAE Vacuum Gauge



## INDUSTRIAL VACUUM PUMP

### VRD SERIES

Excellent Performance

Suitable for production line



Adjustable gas ballast valve



Oil anti-sucking



Internal forced oil cycling system, more reliable

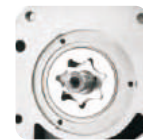

The integrated cylinder structure



### Specification

Model		VRD-16	VRD-24	VRD-30
Displacement speed m <sup>3</sup> /h	50 Hz	16 (4.4)	24(6.6)	30(8.3)
	60 Hz	19.2 (5.2)	28.8 (7.9)	36 (9.9)
Ultimate partial pressure gas ballast close		4x10 <sup>-2</sup> Pa	4x10 <sup>-2</sup> Pa	4x10 <sup>-2</sup> Pa
Ultimate total pressure gas ballast close		4x10 <sup>-1</sup> Pa	4x10 <sup>-1</sup> Pa	4x10 <sup>-1</sup> Pa
Ultimate total pressure gas ballast open		8x10 <sup>-1</sup> Pa	8x10 <sup>-1</sup> Pa	8x10 <sup>-1</sup> Pa
Power supply		single/3-ph	single/3-ph	single/3-ph
Power rating(kw)		0.75kW/0.55kW	1.1kW/0.75kW	1.1kW
Inlet and exhaust DN		KF25	KF25/40	KF25/40
Oil capacity(L)		0.9~1.5L	1.3~2.0L	1.3~2.0L
Motor speed (rpm)	50 Hz	1440	1440	1440
	60 Hz	1720	1720	1720
Ambient temperature		5~40°C	5~40°C	5~40°C
Noise level (dB)		≤58	≤58	≤58
Weight(Kg)		33Kg	36Kg	37Kg

## INDUSTRIAL VACUUM PUMP

### POWER SERIES

Powerful Fast

Suitable for large engineering equipment, refrigeration equipment and the other vacuum work



The integrated



Six air inlets design



Oil anti-sucking



Internal forced oil cycling system, more reliable



### Specification

Model		VP2120	VP2200
Displacement speed m <sup>3</sup> /h (CFM)	50 Hz	20(12)	36(20)
	60 Hz	24(14)	43(24)
Ultimate partial pressure gas ballast close		4x10 <sup>-2</sup> Pa	4x10 <sup>-2</sup> Pa
Ultimate total pressure gas ballast close		4x10 <sup>-1</sup> Pa	4x10 <sup>-1</sup> Pa
Ultimate total pressure gas ballast open		8x10 <sup>-1</sup> Pa	8x10 <sup>-1</sup> Pa
Power supply		single/3-ph	single/3-ph
Power rating(kw)		0.75/0.55kW	1.1/0.75kW
Inlet and exhaust DN		7/16"-20UNF	7/16"-20UNF
Oil capacity(L)		0.9~1.5L	1.3~2.0L
Motor speed (rpm)	50 Hz	1440	1440
	60 Hz	1720	1720
Ambient temperature		5~40°C	5~40°C
Noise level (dB)		≤58dB	≤58
Weight(Kg)		37Kg	41Kg



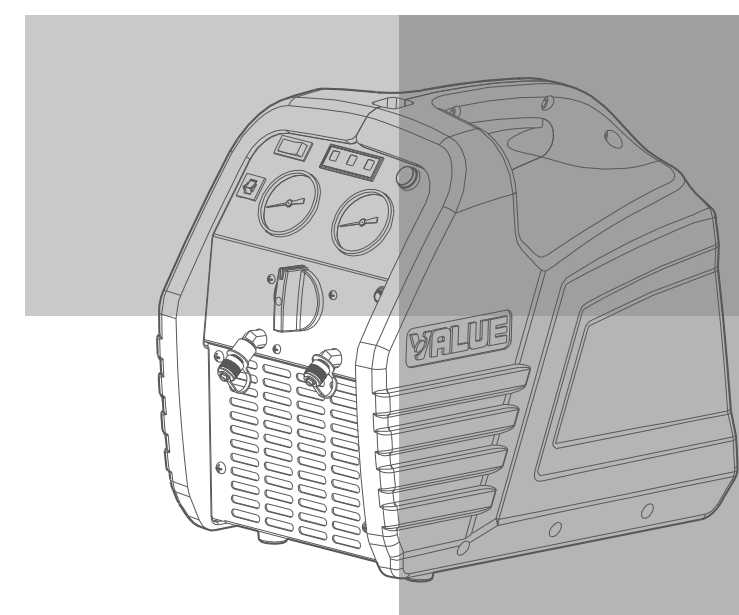

# Recovery Unit

Higher  
Faster

**VALUE**  
VRR24L

**REFRIGERANT RECOVERY UNIT**

VOLTAGE: 110/230VAC/50Hz  
OUTPUT POWER: 1 HP  
DESIGNATED REFRIGERANTS: CLASS 2, 3, 4, 5

**WARNING**

- This unit should be operated only by qualified operators!
- Read all safety operating guidelines and instructions carefully before starting the unit.
- Operate the unit always with safety goggles and protective gloves.
- Operate the unit with a minimum recovery pressure of 40 bar (582.6 psi) unless the unit is used with a reliable recovery tank with a minimum recovery pressure of 10 bar (145 psi).
- Only a reliable recovery tank with a minimum recovery pressure of 10 bar (145 psi) should be used in case of 80% O.P.P. or a tank must be used with an automatic venting procedure in case of 100% O.P.P.
- This equipment should be used in accordance with applicable ventilation procedures in case of 100% O.P.P.
- Do not use this equipment in the vicinity of ignited or vapor containers or operations.
- Do not use this equipment in the vicinity of 12 AWG minimum and no longer than 7.5m (24.6ft) grounding.
- Use a 3-wire extension cord 12 AWG minimum and no longer than 7.5m (24.6ft) grounding.
- The lead pressure must not exceed 25 bar (377.1 psi).

© 2018 VALUE CREATES VALUE  
www.valuecreatesvalue.com



## RECOVERY UNIT



Work status indication lamps



One-key operation more convenient



Start switch



Oil-less input/ Output gauge



Optional 80% over filled protection

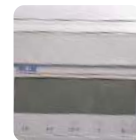

Digital gauge



Work status indication lamps



One-key operation more convenient



Basket handle



Optional 80% over filled protection

## M SERIES RECOVERY UNIT



• Chinese patent



### VRR12M

Smaller, lighter, and more convenient

#### Suit for R32 1234yf refrigerant

- Brushless motor, energy saving
- One key operation, easy to use
- Digital gauge, easy to read
- Equipped with high, low pressure protection
- self-purge function
- One-piston, brushless DC motor 3/4HP

Only 7.8Kg

### VRR24M-B

#### Suit for R32 1234yf refrigerant

- Brushless motor, energy saving
- One key operation, easy to use
- Digital gauge, easy to read
- Equipped with high, low pressure protection
- self-purge function
- Two-piston, brushless DC motor 1HP

Only 10Kg

### Specifications

Model	VRR12M			VRR24M-B			
Refrigerants	Categorys III : R12,R134a,R401C,R500,1234yf Categorys IV : R22,R401A, R401B, R402B, R407C, R407D, R408A,R409A,R411A R411B,R412A,R502,R509 Categorys V : R402A,R404A,R407A,R407B,R410A,R507,R32						
Power Supply	220-240V~/50-60Hz	115V~/60Hz		220-240V~/50-60Hz	115V~/60Hz		
Motor	Brushless DC motor 3/4 HP			Brushless DC motor 1 HP			
Motor Speed	3000rpm			3000rpm			
Maximal Current Draw	2.6A	5.5A		5A	10 A		
Compressor	Oil-less, Air-cooled, Piston style						
Automatic safety Shut-Off	38.5bar/3850kPa(558psi)						
Recovery Rate (Kg/min)	Vapor	Category III	Category IV	Category V	Category III	Category IV	Category V
	Liquid	0.20	0.25	0.25	0.40	0.50	0.50
	Push/pull	1.76	1.98	2.42	3.30	3.85	3.85
		4.60	5.60	6.30	7.50	8.50	9.50
Operating Temperature	0 °C~40 °C						
Dimensions	304×202×260 mm			380×250×360 mm			
Weight	7.8 Kg			11.0Kg			

## L SERIES RECOVERY UNIT

## L SERIES RECOVERY UNIT



### Mini Recovery Unit VRR12L-R32

- Suitable for 1234yf and r32 refrigerant
- One key operation, easy to use
- No spark

**CE**  
• Chinese patent

Special Designed  
Power Button



### VRR12LOS-R32

- Suitable for 1234yf and r32 refrigerant
- Purification and recycling of the refrigerants



### Mini Recovery Unit VRR24L-R32

- Suitable for 1234yf and R32 refrigerant
- One key operation, easy to use
- No spark

**CE**  
• Chinese patent

Special Designed  
Power Button



### VRR24LOS-R32

- Suitable for 1234yf and r32 refrigerant
- Purification and recycling of the refrigerants

### Specifications

Model	VRR12L-R32		VRR12LOS-R32				
Refrigerants	Category III: R12,R134a,R401C,R500,1234yf						
	Category IV: R22,R401A, R401B, R402B, R407C, R407D, R408A,R409A,R411A R411B,R412A,R502,R509						
	Category V: R402A,R404A,R407A,R407B,R410A,R507,R32						
Power Supply	220V-240V~/50-60Hz	115V~/60Hz	220V-240V~/50-60Hz	115V~/60Hz			
Motor	3/4 HP	3/4 HP	3/4 HP	3/4 HP			
Motor Speed	1450rpm/1750rpm	1750rpm	1450rpm/1750rpm	1750rpm			
Maximal Current Draw	4A	8A	4A	8A			
Compressor	Oil-less, Air-cooled, Piston style						
Automatic safety Shut-Off	38.5bar/3850kPa(558psi)						
Recovery Rate (Kg/min)	Category III	Category IV	Category V	Category III	Category IV	Category V	
	Vapor	0.20	0.25	0.25	0.20	0.25	0.25
	Liquid	1.60	1.80	2.20	1.60	1.80	2.20
Push/pull	4.60	5.60	6.30	4.60	5.60	6.30	
Operating Temperature	0°C~40°C						
Dimensions	450×250×355mm						
Weight	13.0 Kg		14.2 Kg				

### Specifications

Model	VRR24L-R32		VRR24LOS-R32				
Refrigerants	Category III: R12,R134a,R401C,R500,1234yf						
	Category IV: R22,R401A, R401B, R402B, R407C, R407D, R408A,R409A,R411A R411B,R412A,R502,R509						
	Category V: R402A,R404A,R407A,R407B,R410A,R507,R32						
Power Supply	220V-240V~/50-60Hz	115V~/60Hz	220V-240V~/50-60Hz	115V~/60Hz			
Motor	1 HP	1 HP	1 HP	1 HP			
Motor Speed	1450rpm/1750rpm	1750rpm	1450rpm/1750rpm	1750rpm			
Maximal Current Draw	5A	10A	5A	10A			
Compressor	Oil-less, Air-cooled, Piston style						
Automatic safety Shut-Off	38.5bar/3850kPa(558psi)						
Recovery Rate (Kg/min)	Category III	Category IV	Category V	Category III	Category IV	Category V	
	Vapor	0.40	0.50	0.50	0.40	0.50	0.50
	Liquid	3.00	3.50	3.50	3.00	3.50	3.50
Push/pull	7.50	8.50	9.50	7.50	8.50	9.50	
Operating Temperature	0°C~40°C						
Dimensions	450×250×355mm						
Weight	13.5 Kg		14.7 Kg				



## L SERIES RECOVERY UNIT



• Chinese patent

### Mini Recovery Unit VRR12L

#### One Key Operation

- One key operation, easy to use
- Equipped with high pressure protection
- Oil-less compressor
- Self-purge function
- 13.0 Kg, easy to carry



### VRR12L-OS

#### One Key Operation

- Oil separator device
- Purification and recycling of the refrigerants

### Specifications

Model	VRR12L		VRR12LOS				
Refrigerants	Category III: R12,R134a,R401C,R500						
	Category IV: R22,R401A, R401B, R402B, R407C, R407D, R408A,R409A,R411A R411B,R412A,R502,R509						
	Category V: R402A,R404A,R407A,R407B,R410A,R507						
Power Supply	220V-240V~/50-60Hz	115V~/60Hz	220V-240V~/50-60Hz	115V~/60Hz			
Motor	3/4 HP	3/4 HP	3/4 HP	3/4 HP			
Motor Speed	1450rpm/1750rpm	1750rpm	1450rpm/1750rpm	1750rpm			
Maximal Current Draw	4A	8A	4A	8A			
Compressor	Oil-less, Air-cooled, Piston style						
Automatic safety Shut-Off	38.5bar/3850kPa(558psi)						
Recovery Rate (Kg/min)		Category III	Category IV	Category V	Category III	Category IV	Category V
	Vapor	0.20	0.25	0.25	0.20	0.25	0.25
	Liquid	1.60	1.80	2.20	1.60	1.80	2.20
	Push/pull	4.60	5.60	6.30	4.60	5.60	6.30
Operating Temperature	0°C~40°C						
Dimensions	450×250×355mm						
Weight	13.0 Kg		14.2 Kg				

## L SERIES RECOVERY UNIT



• Chinese patent

### Mini Recovery Unit VRR24L

#### Lighter • Faster

- One key operation, easy to use
- Equipped with high pressure protection
- 80% over filling protection
- Twin-piston,oil-less compressor,faster recovery
- Self-purge function



### VRR24L-OS

#### Lighter • Faster

- Oil separator device
- Purification and recycling of the refrigerants

### Specifications

Model	VRR24L		VRR24L-OS				
Refrigerants	Category III: R12,R134a,R401C,R500						
	Category IV: R22,R401A, R401B, R402B, R407C, R407D, R408A,R409A,R411A R411B,R412A,R502,R509						
	Category V: R402A,R404A,R407A,R407B,R410A,R507						
Power Supply	220V-240V~/50-60Hz	115V~/60Hz	220V-240V~/50-60Hz	115V~/60Hz			
Motor	1 HP	1 HP	1 HP	1 HP			
Motor Speed	1450rpm/1750rpm	1750rpm	1450rpm/1750rpm	1750rpm			
Maximal Current Draw	5A	10A	5A	10A			
Compressor	Oil-less, Air-cooled, Piston style						
Automatic safety Shut-Off	38.5bar/3850kPa(558psi)						
Recovery Rate (Kg/min)		Category III	Category IV	Category V	Category III	Category IV	Category V
	Vapor	0.40	0.50	0.50	0.40	0.50	0.50
	Liquid	3.00	3.50	3.50	3.00	3.50	3.50
	Push/pull	7.50	8.50	9.50	7.50	8.50	9.50
Operating Temperature	0°C~40°C						
Dimensions	450×250×355mm						
Weight	13.5 Kg		14.7 Kg				

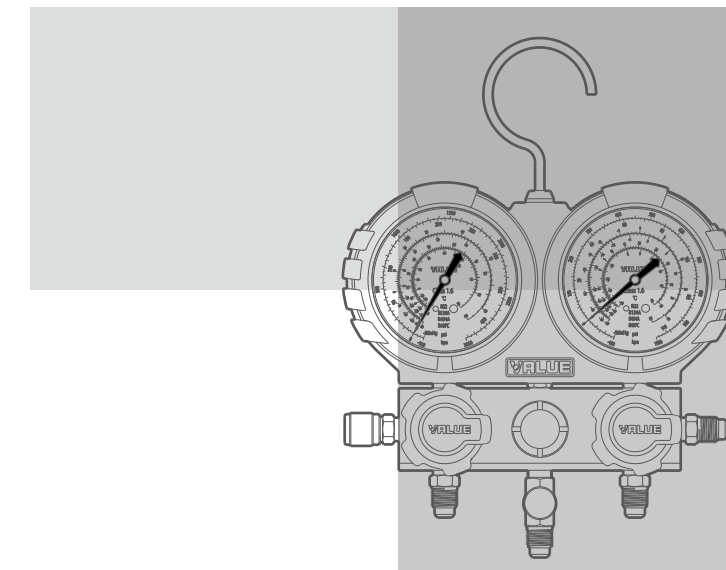

## Refrigerant Tools

Accurate



## MANIFOLD GAUGE

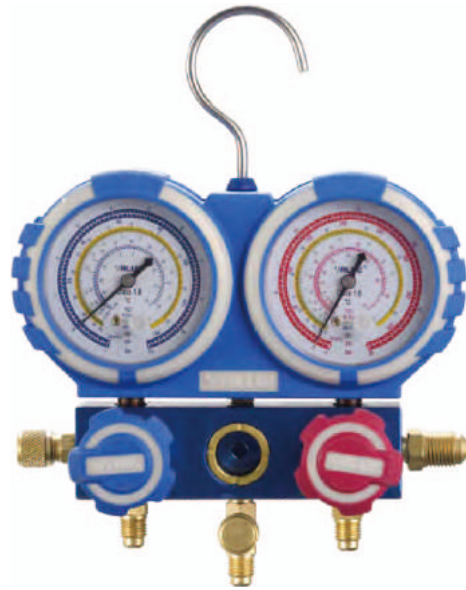

Special material sheath with anti-collision performance



High precision pressure gauge with class 1.6 accuracy



Metal-embedded designed valve to increase strength



Φ12mm high-strength rubber tube to ensure high reliability



Model	VMG-2-R32	VMG-2-R32-B-03
Refrigerant scale	R32	R32, R407, R410A, R134a
Gauge Diameter	Φ80mm	Φ68mm
Pressure Scale	0~80 psi; -30~500 psi	0~80 psi; -30~500 psi
Hose	Red&Blue: 1/4"-5/16", 2x1pc Yellow: 1/4"-1/4", 1pc	/
Length	150cm	/
Package	Blow Case	Blister packing



Model	VMG-2-1234yf
Refrigerant scale	1234yf
Gauge Diameter	Φ80mm
Pressure Scale	0~400 psi; -30~130 psi
Hose	Red&Blue: M12X1.5 - M12X1.5, 2X1pc Yellow: M12X1.5 - 1/2" Acme, 1pc
Length	150cm
Package	Blow Case

## MANIFOLD GAUGE



VMG-2-R410A



VMG-2-R410A-02



VMG-2-R410A-03



VMG-2-R410A-04



VMG-2-R410A-05

Model	VMG-2-R410A	VMG-2-R410A-02	VMG-2-R410A-03	VMG-2-R410A-04	VMG-2-R410A-05
Refrigerants scale	R410A	R410A/R407C/R22/R134a			R410A/R407C/R404A/R134a
Gauge Diameter	Φ80 mm				
Pressure Scale	0~800 psi; -30~500 psi				
Hose	Red&Blue: 1/4"-5/16", 2x1pc Yellow: 1/4"-1/4", 1pc	Red&Blue: 1/4"-5/16", 2x1pc Yellow: 1/4"-1/4", 1pc With 2pcs adapters	Red&Blue: 1/4"-5/16", 2x1pc Yellow: 1/4"-1/4", 1pc	/	Red&Blue: 1/4"-5/16", 2x1pc Yellow: 1/4"-1/4", 1pc
Standard Length	150 cm				
Package	Blow case		Blister packing	Blister packing	Blister packing

NOTICE: All information listed above is standard size, if you require other size, please appoint in the order.



VMG-2-R410A-B



VMG-2-R410A-B-02



VMG-2-R410A-B-03

Model	VMG-2-R410A-B	VMG-2-R410A-B-02	VMG-2-R410A-B-03
Refrigerants scale	R410A/R407C/R22/R134a		
Gauge Diameter	Φ68 mm		
Pressure Scale	0~800 psi; -30~500 psi		
Hose	Red&Blue: 1/4"-5/16", 2x1pc Yellow: 1/4"-1/4", 1pc		/
Standard Length	120 cm		
Package	Blow case	Blister packing	Blister packing

NOTICE: All information listed above is standard size, if you require other size, please appoint in the order.

## MANIFOLD GAUGE



VMG-2-R22



VMG-2-R22-02



VMG-2-R22-03

Model	VMG-2-R22	VMG-2-R22-02	VMG-2-R22-03
Refrigerants scale	R404A/R407C/R134a/R22		
Gauge Diameter	Φ80mm		
Pressure Scale	0~400psi; -30~140psi		
Hose	Red&Blue&Yellow: 1/4"-1/4", 3x1pc		/
Standard Length	120cm		/
Package	Blow Case	Blister packing	Blister packing

NOTICE: All information listed above is standard size, if you require other size, please appoint in the order.



VMG-2-R22-B



VMG-2-R22-B-02



VMG-2-R22-B-03

Model	VMG-2-R22-B	VMG-2-R22-B-02	VMG-2-R22-B-03
Refrigerants scale	R404A/R407C/R134a/R22		
Gauge Diameter	Φ68mm		
Pressure Scale	0~400psi; -30~140psi		
Hose	Red&Blue&Yellow: 1/4"-1/4", 3x1pc		/
Standard Length	120cm		/
Package	Blow Case	Blister packing	Blister packing

NOTICE: All information listed above is standard size, if you require other size, please appoint in the order.

## MANIFOLD GAUGE



VMG-2-R134a



VMG-2-R134a-02

Model	VMG-2-R134a	VMG-2-R134a-02
Refrigerants scale	R134a	
Gauge Diameter	Φ80mm	
Pressure Scale	0~400psi; -30~140psi	
Hose	Red&Blue&Yellow: 1/4"-1/4", 3x1pc	Red&Blue: 1/2"Acme,M14×1.5, 2×1pc Yellow: 1/2"Acme, 1/2"Acme, 1pc
Standard Length	120cm	
Package	Blow Case	
Quick Couplers	VHF-SA 1set	VHF-SB 1set

NOTICE: All information listed above is standard size, if you require other size, please appoint in the order.



VMG-2-R134a-B



VMG-2-R134a-B-02

Model	VMG-2-R134a-B	VMG-2-R134a-B-02
Refrigerants scale	R134a	
Gauge Diameter	Φ68 mm	
Pressure Scale	0~400psi; -30~140psi	
Hose	Red&Yellow&Blue: 1/4"-1/4", 3×1pc	Red&Blue: 1/2"Acme,M14×1.5, 2×1pc Yellow: 1/2"Acme, 1/2"Acme, 1pc
Standard Length	120 cm	
Package	Blow case	
Quick Couplers	VHF-SA 1set	VHF-SB 1set

NOTICE: All information listed above is standard size, if you require other size, please appoint in the order.



## MANIFOLD GAUGE



Special material sheath with anti-collision performance



3/8" port for large system



Sight glass to easily view refrigerant movement and condition



Hose holder fitting 5/16"-1/4"-3/8"-5/16"



Model	VMG-4-R410A
Refrigerants scale	R410A
Gauge Diameter	Φ80 mm
Pressure Scale	0~800 psi; -30~500 psi
Hose	Red&Blue: 1/4"-5/16", 2x1pc 150cm with check valve Yellow: 1/4"-1/4", 1pc 150cm Black: 3/8"-3/8". 1pc 150cm
Package	Blow case

## SINGLE GAUGE



VMG-1-U-H

VMG-1-U-L



VMG-1-S-H

VMG-1-S-L

### Accurate Single Gauge

Suitable for R401A, R134a, R12, R22, R407C, R404A

### Accurate Anti-Collision

- Pressure gauge with high precision movement, precision grade 1.6
- High strength rubber cover, fully anti-collision
- The gauge handle with metal insert with increase the strength

### Specifications

Model	VMG-1-U-H	VMG-1-U-L	VMG-1-S-H	VMG-1-S-L
Gauge Diameter	Φ68mm			
Refrigerants scale (Optional)	ABH/ABL	R134a		
	BBH/BBL	R22/R134a/R404A/R407C		
	CBH/CBL	R22/R134a/R410A/R407C		
	DBH/DBL	R410A		
	EBH/EBL	R404A/R134a/R410A/R407C		
Pressure Scale	-30inHg~800psi	-30inHg~500psi	-30inHg~800psi	-30inHg~500psi
Sight glass	Without		With	
Package	Blister packing		Blister packing	

## PRESSURE GAUGE

High / Low Pressure Gauge	Gauge Diameter	Unit	Refrigerant	MRP NO.	Thread
 <p>ABH      ABL</p>	Φ68mm	°C/°F/ Pis/Bar	R134a	342260108 342260109	NPT1/8"
 <p>BBH      BBL</p>	Φ68mm	°C/Psi/Bar	R22 R134a R404A R407C	342260110 342260111	NPT1/8"
 <p>CBH      CBL</p>	Φ68mm	°C/Psi/Bar	R22 R134a R410A R407C	342260112 342260113	NPT1/8"
 <p>DBH      DBL</p>	68mm	°C/°F/ Psi/Bar	R410A	342260114 342260115	NPT1/8"
 <p>EBH      EBL</p>	Φ68mm	°C/Psi/Bar	R404A R134a R410A R407C	342260118 342260119	NPT1/8"

## PRESSURE GAUGE

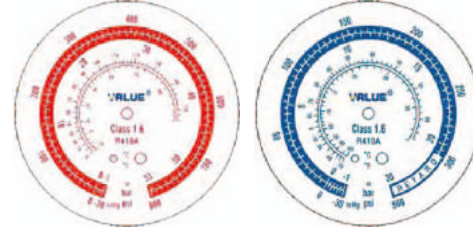
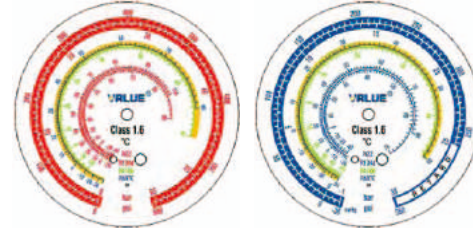
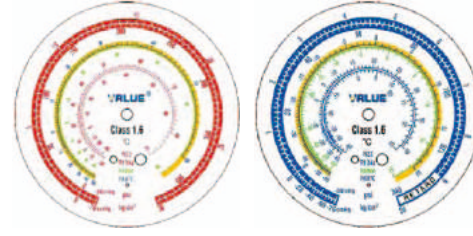
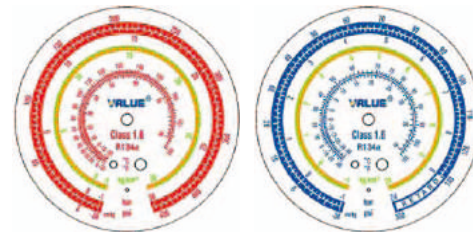
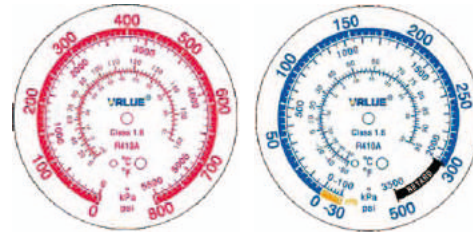
High / Low Pressure Gauge	Gauge Diameter	Unit	Refrigerant	MRP NO.	Thread
 <p>AH      AL</p>	Φ80mm	°C/°F/Pis/Bar	R410A	342260101 342260102	NPT1/8"
 <p>BH      BL</p>	Φ80mm	°C/Psi/Bar	R22 R134a R410A R407C	342260104 342260105	NPT1/8"
 <p>CH      CL</p>	Φ80mm	°C/Psi/ kg/cm <sup>2</sup>	R22 R134a R404A R407C	342260401 342260402	NPT1/8"
 <p>DH      DL</p>	80mm	°C/°F/Psi/ Bar/kg/cm <sup>2</sup>	R134a	342260405 342260406	NPT1/8"
 <p>EH      EL</p>	Φ80mm	°C/°F/ Psi/kPa	R410A	342260409 342260410	NPT1/8"

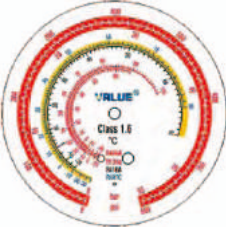
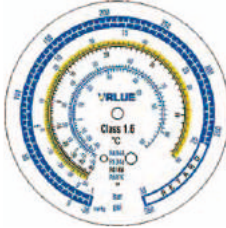
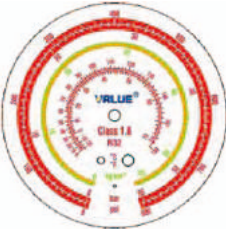
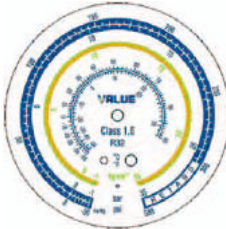
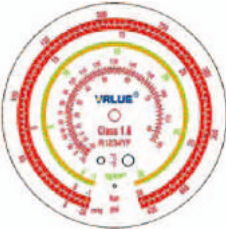
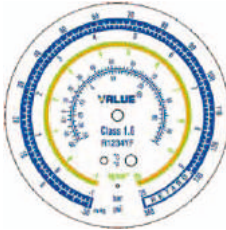

## PRESSURE GAUGE

High / Low Pressure Gauge	Gauge Diameter	Unit	Refrigerant	MRP NO.	Thread
  AH AL	Φ80mm	°C/Bar/Psi	R404A R134a R410A R407C	342260411 342260412	NPT1/8"
  BH BL	Φ80mm	°C/°F/Psi/ Bar/kg/cm <sup>2</sup>	R32	342260413 342260414	NPT1/8"
  CH CL	Φ80mm	°C/°F/Psi/ Bar/kg/cm <sup>2</sup>	1234yf	342260415 342260416	NPT1/8"

## DIGITAL MANIFOLD GAUGE



### Accurate Digital Manifold Gauge

#### VDG-2-S1

- Built-in 9 refrigerant: R22, R32, R290, R410A, 1234yf, R134a, R404A, R407C, R507
- Pressure Display: psi, bar, KPa, MPa, kg/cm<sup>2</sup>
- Temperature Display: °C °F
- Vacuum Display: inHg
- Sensing Accuracy: 0.75% FS
- Sensing Resolution: 1psi
- Hose: Red&Blue: 1/4"-5/16, 2x1pc  
Yellow: 1/4"-1/4". 1pc
- Package: Blow Case



### Accurate Digital Manifold Gauge

#### VDG-4-S1

- Built-in 9 refrigerant: R22, R32, R290, R410A, 1234yf, R134a, R404A, R407C, R507
- Pressure Display: psi, bar, KPa, MPa, kg/cm<sup>2</sup>
- Temperature Display: °C °F
- Vacuum Display: inHg
- Sensing Accuracy: 0.75% FS
- Sensing Resolution: 1psi
- Hose: Red&Blue: 1/4"-5/16, 2x1pc  
Yellow: 1/4"-1/4". 1pc  
Black: 3/8"-3/8" SAE
- Package: Blow Case

## DIGITAL MANIFOLD GAUGE



### Accurate Digital Refrigerant Manifold Gauge VDG-1

- Suitable for detecting 44 refrigerant
- Built-in 9 refrigerant: R11, R123, R404A, R414B, R66A, R428A, R12, R124, R406A, R744, R426A, R417A, R13, R134a, R407A, R422A, 1234yf, R437A, R22, R290, R407C, R422D, R424A, R23, R410A, R408A, R427A, R434A, R728, R32, R401B, R409A, R502, R422B, R113, R402A, R410A, R507A, R416A, R114, R402B, R413A, R508B, R402A
- Including clamp probe for temperature measurement
- Measuring range pressure: -14.5~725psi
- Operating temperature: 10~90% RH
- Net weight 1.2 kg



### Accurate Digital Single Gauge VDG-S1

- Built-in 9 refrigerant: R22, R32, R290, R410A, 1234yf, R134a, R404A, R407C, R507
- Pressure Display: psi, bar, KPa, MPa, kg/cm<sup>2</sup>
- Temperature Display: °C °F
- Vacuum Display: inHg
- Sensing Accuracy: 0.75% FS
- Sensing Resolution: 1psi
- Refrigerant Temperature: -5~50°C
- Connection: 1/4" SAE
- Power: 9V DC battery 50 hours pressure and temperature mode only(continuous use)

## ACCESSORY

### Refrigerant Tube High Strength

- General: suitable for R410A, R134a, R12, R22 refrigerant
- Safe: Rubber tube wall is thickened and the diameter is up to 12mm, to ensure the safety and reliability during the use
- Anti-leakage: High oil resistances, anti-leakage, reach to RMA-A level

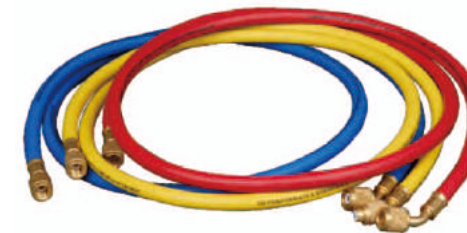

Model	Connector Size		
	R410A	R22	R134a
Pressure Scale	~800 psi	~500psi	~500psi
VRP-U-R	1/4"-5/16"	1/4"-1/4"	1/2"Acme M14×1.5
VRP-U-Y	1/4"-1/4"	1/4"-1/4"	1/2"Acme 1/2"Acme
VRP-U-B	1/4"-5/16"	1/4"-1/4"	1/2"Acme M14×1.5
Lenth	90 cm 120 cm 150 cm		

Model	Connector Size		
	R410A	R22	R134a
Pressure Scale	~800 psi	~500psi	~500psi
VRP-C-R	1/4"-5/16"	1/4"-1/4"	1/2"Acme M14×1.5
VRP-C-Y	1/4"-1/4"	1/4"-1/4"	1/2"Acme 1/2"Acme
VRP-C-B	1/4"-5/16"	1/4"-1/4"	1/2"Acme M14×1.5
Lenth	90 cm 120 cm 150 cm		
Check valve	1set(Optional: CV01-CV06)		

### Quick Couplers

#### VHF SERIES

- VHF-SA/SB/SC suitable for refrigerant R134a, etc.
- VHF-SY suitable for refrigerant R1234yf, etc.
- Automotive air conditioning maintenance tool

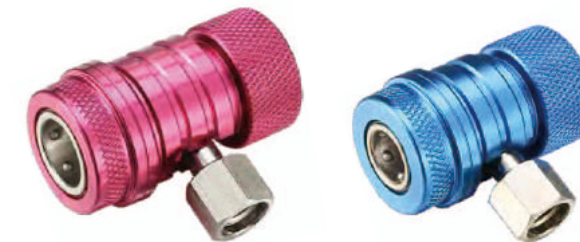

### Safety and Reliable

- Connecting pipeline of car air-conditioning and refrigerant system very fast
- Controlling the pipeline's open and close

Model	VHE-SA(R134a)	VHE-SB	VHE-SC	VHE-SA(1234yf)
Description	1/4" SAE	M14×1.5	3/8" SAE	M12×1.5



## ACCESSORY

### Check Valve



CV01



CV02



CV03



CV04



CV05



CV06



CV07



CV08



CV09



CV10



CV11



CV12

Item	Description	Item	Description
CV01	Male: 1/4"SAE Female: 5/16" SAE	CV07	Male: 1/4"SAE Female: 1/4" SAE
CV02	Male: 1/4"SAE Female: 5/16" SAE 45°	CV08	Male: 5/16"SAE Female: 5/16" SAE 45°
CV03	Male: 1/4"SAE Female: 5/16" SAE 60°	CV09	Male: 5/16"SAE Female: 5/16" SAE 60°
CV04	Male: 5/16"SAE Female: 5/16" SAE	CV10	Male: 5/16"SAE Female: 1/4" SAE
CV05	Male: 1/4"SAE Female: 1/4" SAE 45°	CV11	Male: 5/16"SAE Female: 1/4" SAE 45°
CV06	Male: 1/4"SAE Female: 1/4" SAE 60°	CV12	Male: 5/16"SAE Female: 1/4" SAE 60°

### Adapter



V01



V02



V03



V04



V05



V06



V07



V08

Item	Description	Item	Description
V01	Male: 5/16"SAE 90° Female: 5/16" SAE	V05	Male: 1/4"SAE Female: 5/16" SAE
V02	Male: 1/4"SAE 90° Female: 5/16" SAE	V06	Male: 5/16"SAE Female: 1/4" SAE
V03	Male: 5/16"SAE 90° Female: 1/4" SAE	V07	Male: 1/4"SAE Female: 5/16" SAE
V04	Male: 1/4"SAE 90° Female: 1/4" SAE	V08	Male: 5/16"SAE Female: 1/4" SAE

## LEAK DETECTOR

### VLD-2

#### Accurate Detect

- With three different sensitiveness
- High sensitivity
- Fast response
- Suit for different refrigerants



Refrigerants  
CFC/HCFC/HFC

### Specification

Battery :	4X1.5V AABattery
Battery life :	≥8hours
Sensitivity :	≤3g/year
Sensor life :	1year(normal use)
Ambit temperature :	0-40°C
Calibration:	Automatic
Respond time :	≤3 Second
Probe length :	400mm
Dimension :	230mmX83mmx50mm
Weight :	380g

SCALE







VES-50A/VES-100A



VES-50B/VES-100B

Quantitative filling precision control

Easy operation schematic

- 1 Open the electrical scale 
- 2 Place the refrigerant tank and clear the electrical scale 
- 3 Enter the filling and recovery function, enter the net weight values of the refrigerant, and press Enter 
- 4 When close to fixing weight of filling/recovery, electronic scale will alarm or automatic shut down the valve, and prompts the filling/recovery has been completed 
- 5 After filling/recovery, stop the scale manually, and press Enter 

SCALE



VES-50A/VES-100A

Quantitative Filling Precision Control  
Easy Operation Schematic

The recovery/  
recycling weight can be set,  
convenient for operation



Model	VES-50A	VES-100A
Weighting range	50Kg	100Kg
Resolution	2 g	5 g
Accuracy	±0.05% F.S	
Display	LCD	
Power	DC 9V, at least 80h working time	
Working environment	-10°C~40°C	
Platform size	237×237 mm	
Weight	5 Kg	

VES-50B/VES-100B

Quantitative Filling Precision Control  
Easy Operation Schematic

High precision valve,  
accuracy control,  
filling weight ± 20g

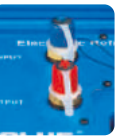

The recovery/  
recycling weight can be set,  
convenient for operation



Model	VES-50B	VES-100B
Weighting range	50Kg	100Kg
Resolution	2 g	5 g
Accuracy	±0.05% F.S	
Display	LCD	
Power	DC 9V/AC(100V~230V)	
Working environment	-10°C~40°C, ≤ 75% Humidity	
Platform size	237×237 mm	
Weight	6.5 Kg	
Automatic shut-off	Yes	



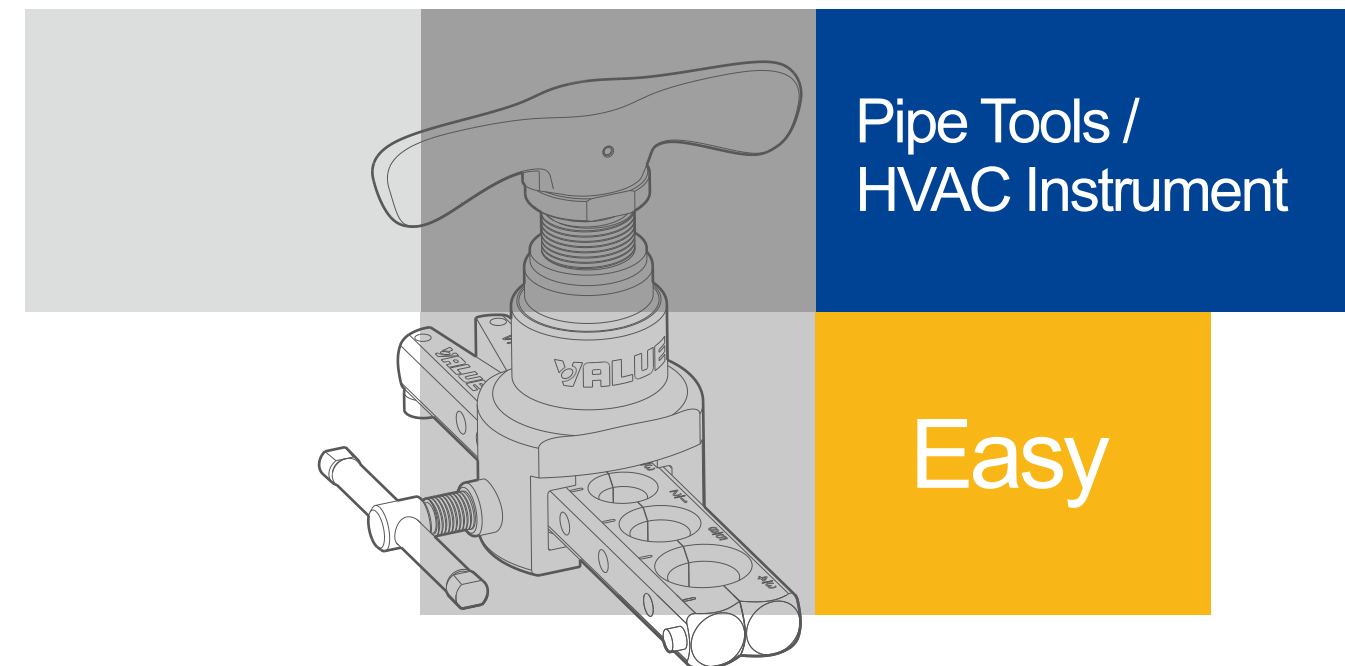



## FLARING TOOL

### VFT-808

#### Accurate Tube Flaring

- 45° eccentric flaring tool in metric and inch sizes
- Heavy duty wide-range bar type flaring tool
- Hardened bars provide positive clamping action with minimum distortion
- Easy to use and exact flaring result



Annular rivet connection



Steel ball positioning, convenient flaring



• Chinese patent

#### Operation



1



2



3

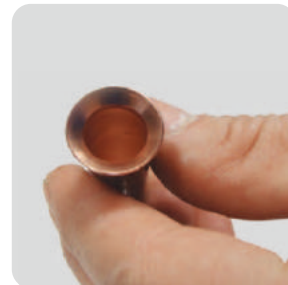

4

## FLARING TOOL



VFT-808-IN



VFT-808-I



VFT-808-I-02



VFT-808-MI

Model	Tube O.D.	Applicable pipe	Packaging
VFT-808-IN	1/4", 5/16", 3/8", 1/2", 5/8", 3/4"	Copper pipe	Blister packing
VFT-808-I			Blow case
VFT-808-I-02			Carton
VFT-808-MI	6, 8, 10, 12, 16, 19mm 1/4", 5/16", 3/8", 1/2", 5/8", 3/4"		Blow case
VFT-808-MI-02	6,8,10,12,15,16,18mm 1/4", 5/16", 3/8", 1/2", 5/8", 3/4"		Blow case



VFT-808-MI-02



VFT-808-IS



VFT-808-MIS



VFT-808-IE

Model	Tube O.D.	Tube Tool	Applicable pipe	Packaging
VFT-808-IS	1/4", 5/16", 3/8", 1/2", 5/8", 3/4"	VTC-28B	Copper pipe	Blow case
VFT-808-MIS	6, 8, 10, 12, 16, 19mm 1/4", 5/16", 3/8", 1/2", 5/8", 3/4"	VTC-28B		Blow case
VFT-808-IE	1/4", 5/16", 3/8", 1/2", 5/8", 3/4"	VST-22		Blow case



## FLARING TOOL



### VFT-809

#### Accurate Tube Flaring

- Easy operation, save time and
- special design for R410A system
- The special cone eccentric revolution will allow the internal opening gradually and form 45° accurately and regularly, prevent the tube slippage downward. Therefore, the flaring face will be smooth, uniform without scratching.
- Eccentric cone will rebound by itself after the work is finished. To make the idle top head in revolution again for 1-2 more rounds, with the friction the flaring face will be more smooth and prettier.

• Chinese patent



VFT-809-I



VFT-809-IS

Model	Tube O.D.	Tube Cutter	Packaging
VFT-809-I	1/4", 5/16", 3/8", 1/2", 5/8", 3/4"	/	Blow case
VFT-809-IS	1/4", 5/16", 3/8", 1/2", 5/8", 3/4"	VTC-28B	

## FLARING TOOL



### VFT-808C

#### Axial Spacing Accurate Tube Flaring

- Axial spacing to ensure the accurate size
- Innovative patent clamping structure for convenient operation
- Innovative design, operating more humane

• Chinese patent



VFT-808C

Model	Tube O.D.	Tube Cutter	Packaging
VFT-808C	1/4", 5/16", 3/8", 1/2", 5/8", 3/4"	/	Blow case

Axial spacing  
Accurate tube flaring

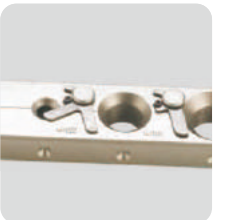

Convenient loading and  
unloading Quick clamping



## FLARING TOOL

### Electrical Flaring Tool

#### VET-19-S

#### Quick Flaring

- 5-second fast and accurate flaring
- Single head, easy to use for small space
- Not limited by environment condition

#### Operation

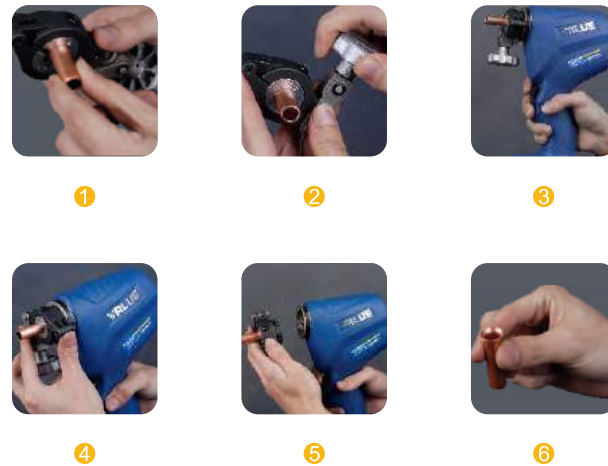

• Chinese patent

#### Specification

Power supply :	Battery
Applicable Pipe :	Copper pipe
Tube O.D. :	1/4", 5/16", 3/8", 1/2", 5/8", 3/4"
Flaring shape :	Flared
Tuber cutter:	VTC-28B
Deburring tool:	VTT-5



## BENDING TOOL

### Easy Bending

- Twin roller design reduces the friction, makes the bending more convenient
- Human factor designed two-period bending, makes big angle bending easy
- Unique pre-deformation design, ensures the tube's evenness and quality



VBT-1/2

• Chinese patent

#### Specification

Model	VBT-1	VBT-1A	VBT-2	VBT-2A
Bending Size	3/8"	10mm	1/2"	12mm
Bending Radius	15/16"	15/16"	1-1/2"	1-1/2"
Bending Angle	0~180°			
Applicable Material	All soft pipes, thin-wall copper pipes and annealed treated hard pipe			

### Easy Bending

- Twin roller design reduces the friction, makes the bending more convenient
- Human factor designed two-period bending, makes big angle bending easy
- Unique pre-deformation design, ensures the tube's evenness and quality



VBT-3/4/5

• Chinese patent

#### Specification

Model	VBT-3	VBT-4	VBT-5
Bending Size	5/8",16mm	3/4",19mm	7/8",22mm
Bending Radius	2-1/4"	3"	3-1/4"
Bending Angle	0~180°		
Applicable Material	All soft pipes, thin-wall copper pipes and annealing treated hard pipe		



## TUBE EXPANDER



• Chinese patent

### VHE-29A/29B/42B

#### Easy to expand

- No copper coupling needed any more
- Only one side needs to be welded. Less welding rod, oxygen and ethyne to be used
- Lessen the possibility of leakage of the weld
- Manual hydraulic mechanism design can expand tubing from 3/8" to 1-5/8" diameter

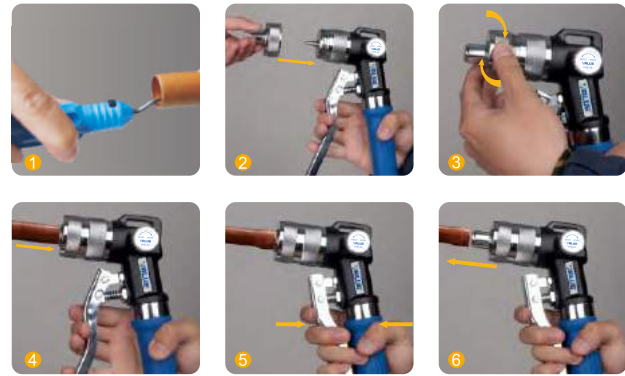

#### Six easy steps

- 1 Deburr inside of tube
- 2 Anneal the tube if necessary (for hard or thickwall tube)
- 3 Screw the expander head on expander
- 4 Put the end of tube on expander head
- 5 Tighten the relief valve knob to 'on' position then pump handle until tube is expanded to the end
- 6 Tighten the relief valve knob to 'off' position to loosen expander head, remove expanded tube

Model	Tube O.D.	Diameter	Size	Weight	Accessory
VHE-29A	3/8", 1/2", 5/8", 3/4", 7/8", 1", 1-1/8"	φ 46mm	390×245×74mm	3.3Kg	/
VHE-29AM	10, 12, 15, 16, 18, 22, 28mm	φ 46mm	390×245×74mm	3.3Kg	/
VHE-29B	3/8", 1/2", 5/8", 3/4", 7/8", 1", 1-1/8"	φ 46mm	390×245×74mm	3.7Kg	VTT-5 VTC-32
VHE-29BM	10, 12, 15, 16, 18, 22, 28mm	φ 46mm	390×245×74mm	3.7Kg	VTT-5 VTC-32
VHE-42B	3/8", 1/2", 5/8", 3/4", 7/8", 1", 1-1/8" 1-1/4", 1-3/8", 1-1/2", 1-5/8"	φ 46mm	390×245×74mm	5.3Kg	VTT-5 VTC-42
VHE-42BM	10, 12, 15, 16, 18, 22, 28, 35, 42mm	φ 46mm	390×245×74mm	5.3Kg	VTT-5 VTC-42

## TUBE EXPANDER



• Chinese patent



### VHE-29C/42C

#### Two Usage For Flaring & Expanding

- Two usage for flaring & expanding, easy to shift
- No copper coupling needed any more
- Only one side needs to be welded. Less welding rod, oxygen and ethyne to be used
- Lessen the possibility of leakage of the weld
- Manual hydraulic mechanism design can expand tubing from 3/8" to 1-5/8" diameter



Model	Expanding tube O.D.	Flaring tube O.D.	Accessory
VHE-29C	3/8", 1/2", 5/8", 3/4", 7/8", 1", 1-1/8"	1/4", 3/8", 1/2", 5/8", 3/4", 5/16"	VTT-5 / VTC-32
VHE-29CM	10, 12, 15, 16, 18, 22, 28mm		VTT-5 / VTC-32
VHE-42C	3/8", 1/2", 5/8", 3/4", 7/8", 1", 1-1/8" 1-1/4", 1-3/8", 1-1/2", 1-5/8"		VTT-5 / VTC-42
VHE-42CM	10, 12, 15, 16, 18, 22, 28, 35, 42mm		VTT-5 / VTC-42

## TUBE EXPANDER

### VST-22B Easy to Carry

Invention patent  
Using the most simple structure for brass pipe expanding

Model	Tube O.D.
VST-22B	1/4", 5/16", 3/8", 1/2", 5/8", 3/4", 7/8" 6~13mm, 16~22.3mm



• Chinese patent

### Patent for invention



1

2

3

4

5

## TUBE CUTTER

### Sharp Tube Cutter

- Grinding blade, uses high-quality alloy tool steel, grinding process
- Unique ball bearing design, easy cutting



• Chinese patent

VTC-28B/32/35/42/70



VTC-19/28

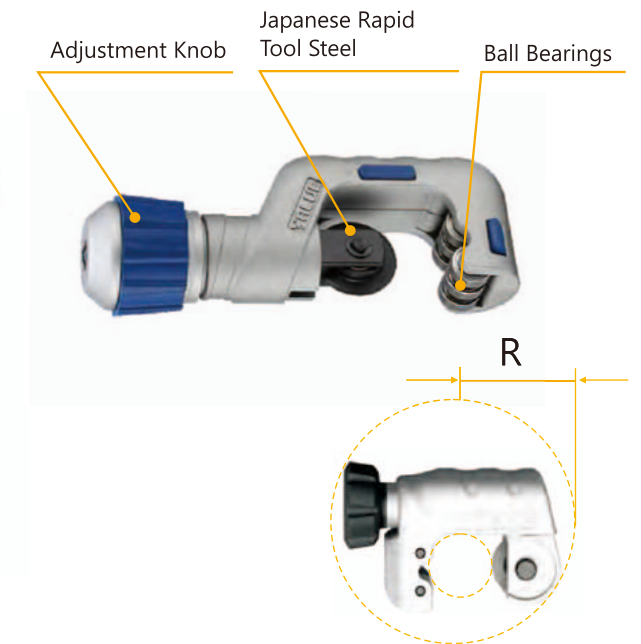

Model	Description
VTC-19	For 1/8"~3/4" (3~19mm)
VTC-28	For 1/8"~1-1/8" (4~28mm)
VTC-28B	For 1/8"~1-1/8" (4~28mm)
VTC-32	For 1/8"~1-1/4" (4~32mm)
VTC-35	For 1/8"~1-3/8" (4~35mm)
VTC-42	For 1/4"~1-5/8" (6~42mm)
VTC-70	For 1/4"~2-5/8" (6~67mm)



PIPE TOOLS



**Deburring Tool  
VTT-5**

- Well polished surface. Compared with other deburring tools, VALUE deburring tool adopts sharp cutting edge, provide you a better finish.
- Easy to use and saving cost. VALUE deburring tool is convenient to carry with, and easy to change blade.
- Two extra blades in side
- Easy to change the blade by push the button



**Capillary Tube Plier  
VRT-101**

Tube O.D. 1~3mm( $\leq 1/8$ " ) thin brass tube  
Specification: 5" (125 mm)  
Suitable: Tube O.D. 1~3mm( $\leq 1/8$ " ) thin brass tube



**Sealing Pliers  
VRT-102**

Clamp tube to be deplanate and sealed  
Specification: 1/8"~3/8" (3~10mm)  
Suitable: varied thin brass or aluminum tube

PIPE TOOLS



**Ratchet Spanner  
VRT-201/202**

Twist screw or nut fast  
VRT-201: 1/4", 3/8", 3/16", 5/16"  
VRT-202: 1/4", 3/16", 9/16", 1/2"  
Suitable: varied screw or nut



**Deburring Tool  
VRT-301**

Material: Plastic  
Burr varied kinds of tube  
Specification: tube O.D. 1/8"~1-5/8" (4~40mm)  
Suitable: varied brass tube, aluminum tube or PVC



**Deburring Tool  
VRT-302**

Material: Aluminium alloy  
tube O.D. :3/16"~1-3/8" (5~35mm)  
Plentiful teeth design  
Skidproof aluminium alloy shell  
Applicable for various rigid tubes such as stainless steel

TOOL KIT



**Tool Kit  
VTB-5A**

Complete with	Description	Quantity
Vacuum pump	1.5CFM	1pc
Flaring tool	VFT-808-I	1set
Tube cutter	VTC-28B	1pc
Scraper	VTT-5	1pc
Manifold gauge	VMG-2-R410A	1set
Tube expanders	VST-22	1pc
Package	Aluminum alloy box	1pc



**Tool Kit  
VTB-5D**

Complete with	Description	Quantity
Flaring tool	VFT-808-MI	1set
Tube cutter	VTC-32	1pc
Scraper	VTT-5	1pc
Manifold gauge	VMG-2-R410A-B	1set
Tube expanders	VST-22	1pc



**Tool Kit  
VTB-8C**

Item	Model	Quantity
Flaring Tool	VFT-808-MI	1set
Tube cutter	VTC-32	1pc
Manifold Gauge	VMG-2-R410A-B	1set
Digital Clamp Multimeters	VCM-202	1pc
Tube Expander	VST-22	1pc
Deburring Tool	VTT-5	1pc
Ratchet Spanner	VRT-201	1pc
Ratchet Spanner	VRT-202	1pc

TOOL KIT



**Tool Kit  
VTB-5B- I**

Complete with	Description	Quantity
Flaring tool	VFT-808-I	1set
Tube cutter	VTC-28B	1pc
	VTC-19	1pc
Manifold gauge	VMG-2-R410A	1set
Scraper	VTT-5	1pc
Package	Blow case	1pc



**Tool Kit  
VTB-5B- II**

Complete with	Description	Quantity
Flaring tool	VFT-808-I	1set
Tube cutter	VTC-28B	1pc
	VTC-19	1pc
Manifold gauge	VMG-2-R410A	1set
Adapter	Optional: V01 V08	1set
Scraper	VTT-5	1pc
Package	Blow case	1pc



**Tool Kit  
VTB-5B- III**

Complete with	Description	Quantity
Flaring tool	VFT-808-I	1set
Tube cutter	VTC-28B	1pc
	VTC-19	1pc
Manifold gauge	VMG-2-R410A	1set
Adapter	Optional: V01-V08	1set
Check valve	Optional: CV01-CV12	1set
Scraper	VTT-5	1pc
Package	Blow case	1pc



## HVAC INSTRUMENT

### Modern Digital Multimeters VDM-132C

- 30 different measuring ranges can be selected
- Overload protection for the full range
- The function to keep number of all shifts
- Working temperature: 0°C~40°C
- Storage temperature: -10°C~50°C
- Weight: 300 g



### Digital Clamp Multimeters VCM-210

- Suitable for measuring AC/DC voltage, AC current, resistance, diode, °C/°F temperature and so on
- Automatic shut down for saving energy and low battery alarm
- 250V overload protection
- Max measurement voltage: 600V
- Max measurement AC current: 400A
- Temperature measurement range: -40°C~1000°C
- Weight: 360 g



### Infrared Thermometer VIT-300S

- Emissivity: 0.95
- Temperature range: -32°C~400°C
- Max measuring accuracy: ±2°C or ±2%
- Ambient operation temperature: 23°C±2°C
- Resolution: 0.1
- Response time: 500 ms
- Weight: 185 g



## HVAC INSTRUMENT



### Sound level meter VSM351

Model:	VSM351
Noise measurement scope:	30-130dB
Dimensions:	272X70X39mm
Weight:	386g



### Anemometer VAM361

Model:	VAM361
Wind speed measurement scope:	2-30m/s
Dimensions:	166X80X35mm
Weight:	375g



### Rotating speed meter VRM371

Model:	VRM371
Range:	0~99999r/min
Dimensions:	184X56X34mm
Weight:	100g ( excluding battery )